

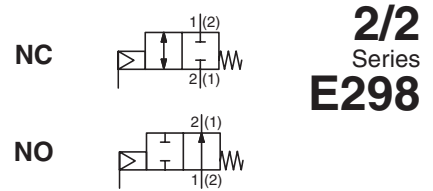

VALVES

pressure operated
stainless steel body
with threaded ports PN40, 1/2 to 2



2/2
Series
E298

FEATURES

- Ruggedly built valve, particularly recommended for use with steam, superheated water, corrosive fluids
- High-performance, maintenance-free stuffing box, resistant to thermal shock
- Pressure can be applied to any port as needed by the process
- Anti-waterhammer design (fluid entry at orifice 1), recommended for use with liquids
- Vacuum operation up to 10^{-2} mbar
- Allowable backpressure: up to 40 bar
- Optical position indicator as standard
- Autoclavable valve for use at high ambient temperatures (up to 180°C)
- The valves satisfy Pressure Equipment Directive 97/23/EC
- The valves in conformity with IEC 61508 Standard (2010 route 2_H version) certified with integrity levels: SIL 2 for HFT = 0



GENERAL

Differential pressure	0 to 40 bar [1 bar = 100 kPa]
Maximum allowable pressure	40 bar (within the specified limits, see diagram I)
Ambient temperature range	-25°C to +180°C
Maximum viscosity	5000 cSt (mm ² /s)
Pilot fluid	Air
Max. pilot pressure	10 bar
Min. pilot pressure	See below

fluids (*)	temperature range	disc seal (*)
DN 15-20-25: air and gas groups 1 & 2 DN 32-40-50: air and gas group 2 all DN: water, oil, liquids groups 1 & 2 and steam	-10°C to +250°C	bronze PTFE

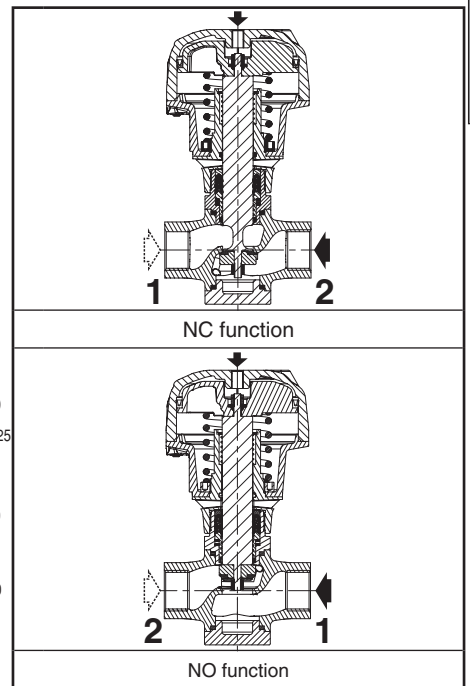
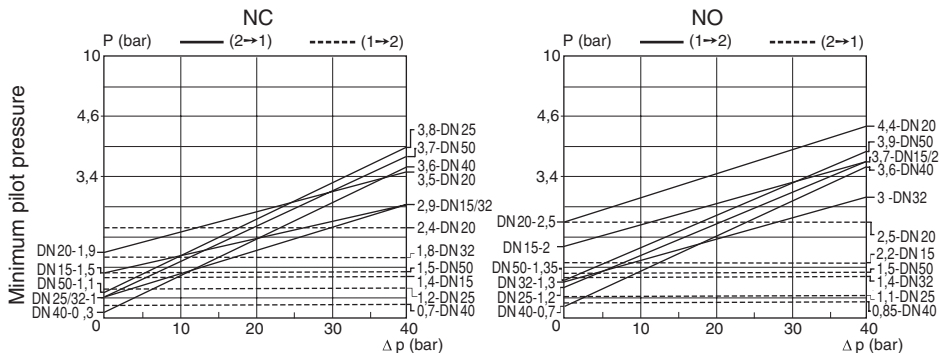

MATERIALS IN CONTACT WITH FLUID

(*) Ensure that the compatibility of the fluids in contact with the materials is verified

Valve body and plug	Stainless steel
Stuffing box housing	Stainless steel
Stem, disc	Stainless steel
Stuffing box packing	PTFE chevrons
Disc seal	Bronze PTFE
Valve body seal	Graphite

OTHER MATERIALS

Operator	Aluminium, nickel plated
----------	--------------------------

SPECIFICATIONS

piping (ISO 6708)	pipe size	DN	flow coefficient Kv				pilot pressure (bar)		operating pressure differential (bar)	operator diameter (mm)	catalogue number
			1 → 2		2 → 1		min.	max.			
(G*)			(m ³ /h)	(l/min)	(m ³ /h)	(l/min)					
NC - Normally closed											
1/2	15	4,4	73	5	83	*	10	40	80	E298A001	
3/4	20	7,7	128	8,5	142	*	10	40	100	E298A002	
1	25	11,5	192	12	200	*	10	40	100	E298A003	
1 1/4	32	18	300	18	300	*	10	40	150	E298A004	
1 1/2	40	29	483	29	483	*	10	40	150	E298A005	
2	50	57	950	57	950	*	10	40	200	E298A006	

* Minimum pilot pressure varies with differential pressure. See piloting chart above.

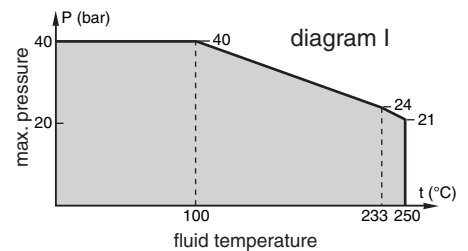

00172GB-2014/R02
Availability, design and specifications are subject to change without notice. All rights reserved.

SPECIFICATIONS

piping (ISO 6708)		flow coefficient Kv				pilot pressure (bar)		operating pressure differential	operator diameter	catalogue number
pipe size	DN	1 → 2		2 → 1		min.	max.	(bar)	(mm)	
		(m³/h)	(l/min)	(m³/h)	(l/min)					
(G*)										
NO - Normally open										
1/2	15	3,5	58	3,5	58	*	10	40	80	E298A007
3/4	20	7,2	120	7	117	*	10	40	100	E298A008
1	25	11	183	11	183	*	10	40	100	E298A009
1 1/4	32	18	300	15	250	*	10	40	150	E298A010
1 1/2	40	28,2	470	28,2	470	*	10	40	150	E298A011
2	50	53	883	53	883	*	10	40	200	E298A012

* Minimum pilot pressure varies with differential pressure. See piloting chart on previous page.

OPTIONS AND ACCESSORIES

- Metal-to-metal sealing disc
- Signaling box, with mechanical or inductive contacts
- Low ambient temperatures - Temperature range: -50°C to +70°C
- ATEX 94/9/EC versions for potentially explosive atmospheres, categories 2 GD and 3 GD
- 2 switches, Ex d protection, mounted on valve with 2 Crouzet contacts type 83101-I-W1, for use in ambient temperatures from -20°C to +80°C: suffix **SD2** [Contact us for option with 1 Honeywell contact type 1HS1 (-55°C to +82°C) or 1 Crouzet contact (-20°C to +80°C).]
- Valve seat leakage class VI as defined by FCI 70-2, contact us
- Other pipe connections are available on request

INSTALLATION

- The valves can be mounted in any position without affecting operation
- Compatible with ASTM 1, 2 and 3 oils
- Check temperature range of valve body and solenoid pilot valves for suitability. For probability of failure, contact us
- Pipe connections (G*) have standard thread according to ISO 228/1 and ISO 7/1. Pipe connections (G) have standard thread according to ISO 228/1
- Installation/maintenance instructions are included with each valve

SPARE PARTS KITS

catalogue number	spare parts kit no.		
	piston seal	actuator spring	stem, disc, seals
E298A001	C140233	C140299	C140311
E298A002	C140234	C140301	C140313
E298A003	C140234	C140303	C140315
E298A004	C140235	C140305	C140317
E298A005	C140235	C140307	C140319
E298A006	C140298	C140309	C140321
E298A007	C140233	C140300	C140312
E298A008	C140234	C140302	C140314
E298A009	C140234	C140304	C140316
E298A010	C140235	C140306	C140318
E298A011	C140235	C140308	C140320
E298A012	C140298	C140310	C140322

ORDERING EXAMPLES:

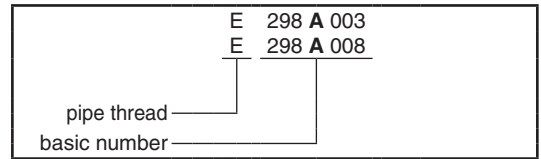

ORDERING EXAMPLES KITS:

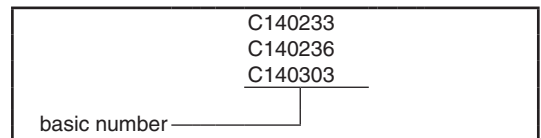

DIMENSIONS (mm), WEIGHT (kg)



TYPE 01-02-03-04

Prefix "E"

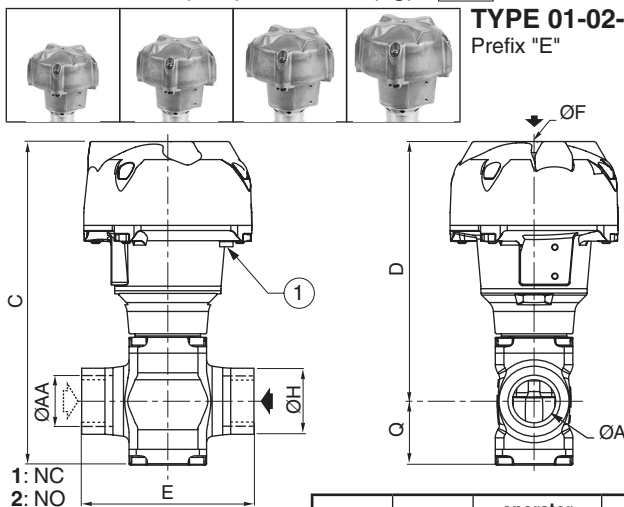

① Optical position indicator

type	DN	operator diameter	ØA	ØAA	ØB	C	D	E	ØF	ØH	ØP	Q	weight	
													NC	NO
01	15	80	15	1/2"	110	184,1	151,6	85	G 1/8	33	95	32,5	1,82	1,80
	20	100	20	3/4"	132,5	209,9	170,9	110	G 1/8	40	117	39	3,44	3,46
02	25	100	25	1"	132,5	225,4	180,9	120	G 1/8	46	117	44,5	4,16	4,12
	32	150	32	1"1/4	191	291,2	237,2	145	G* 1/4	57	172,5	54	9,32	9,26
03	40	150	40	1"1/2	191	325,7	259,2	150	G* 1/4	65	172,5	66,5	11,38	11,36
	50	200	50	2"	247	409	328,5	190	G* 1/4	75	230	80,5	23,48	21,68

All leaflets are available on: www.asconumatics.eu